

Before using this machine for the first time, read this Quick Setup Guide to setup and install your machine. To view the Quick Setup Guide in other languages, please visit <http://solutions.brother.com/>.







Note

Not all models are available in all countries.

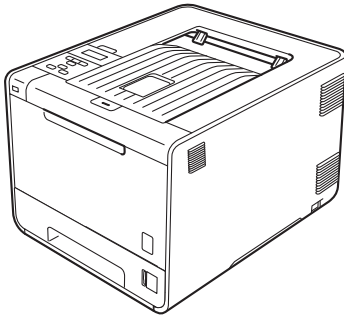
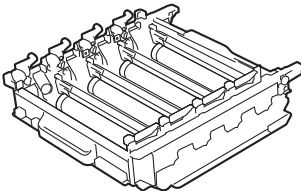
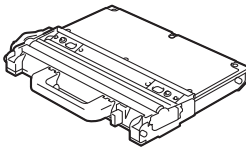
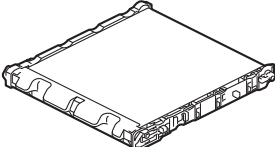
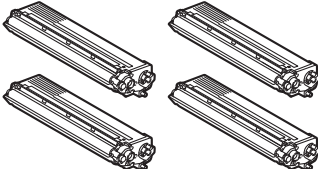
<p>⚠ WARNING</p>	<p><u>WARNING</u> indicates a potentially hazardous situation which, if not avoided, could result in death or serious injuries.</p>
<p>⚠ CAUTION</p>	<p><u>CAUTION</u> indicates a potentially hazardous situation which, if not avoided, may result in minor or moderate injuries.</p>

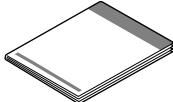
1 Unpack the machine and check the components

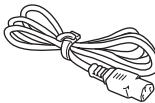
	 <p>Drum Unit (pre-installed)</p>	 <p>Waste Toner Box (pre-installed)</p>	 <p>Belt Unit (pre-installed)</p>
 <p>Starter Toner Cartridges (pre-installed) (Black, Cyan, Magenta and Yellow)</p>	 <p>Documentation/Installation CD-ROM(s)</p>	 <p>Quick Setup Guide</p>	
 <p>Safety and Legal Booklet</p>		 <p>AC Power Cord</p>	

WARNING

- Plastic bags are used in the packaging of your machine. Plastic bags are not toys. To avoid danger of suffocation, please keep these bags away from babies and children and dispose of them properly.
- This machine is heavy and weighs approximately 21.0 kg (46.3 lb.). To prevent possible injuries at least two people should lift the machine. Be careful not to pinch your fingers when you put the machine down.
- If you use a Lower Tray, carry it separately from your machine.

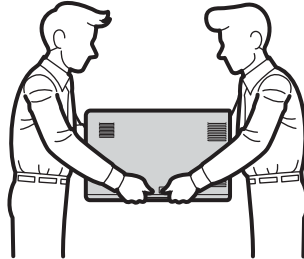

Note

- Keep a minimum gap around the machine as shown in the illustration.

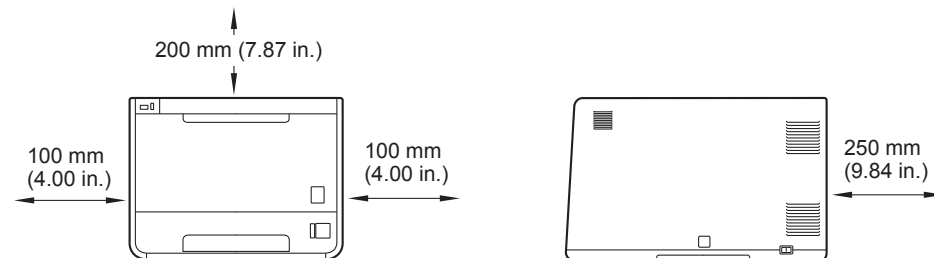

- The components included in the box may differ depending on your country.
- We recommend that you save the original packaging.
- If for any reason you must ship your machine, carefully repack the machine in the original packaging to avoid any damage during transit. The machine should be adequately insured with the carrier. How to repack the machine, see *Shipment of the machine* in the *User's Guide*.
- Illustrations in this Quick Setup Guide are based on the HL-4570CDW.
- The interface cable is not a standard accessory. Buy the appropriate interface cable for the interface you want to use (USB or Network).

USB cable

It is recommended to use a USB 2.0 cable (Type A/B) that is no longer than 2 meters (6 feet).

Network cable

Use a straight-through Category5 (or greater) twisted-pair cable for 10BASE-T or 100BASE-TX Fast Ethernet Network.

2 Remove the packing material from the machine

! IMPORTANT

DO NOT connect the AC power cord yet.

a Remove the packing tape from the outside of the machine.

b Open the MP tray **1**, and remove the plastic sheet **2** from the MP tray support, then close the MP tray.

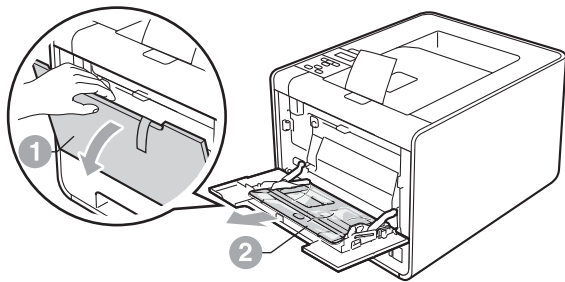

c Press the front cover release button and open the front cover. Remove the silica gel pack **1**.

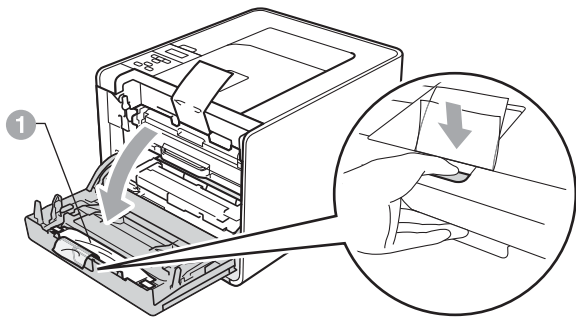

! CAUTION

DO NOT eat Silica Pack. Discard immediately.

d Hold the green handle of the drum unit **1** and pull it out until it stops.

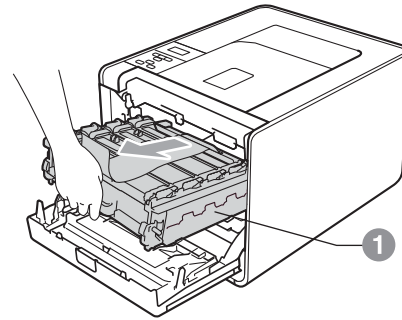

e Hold the orange packing material, and remove it.

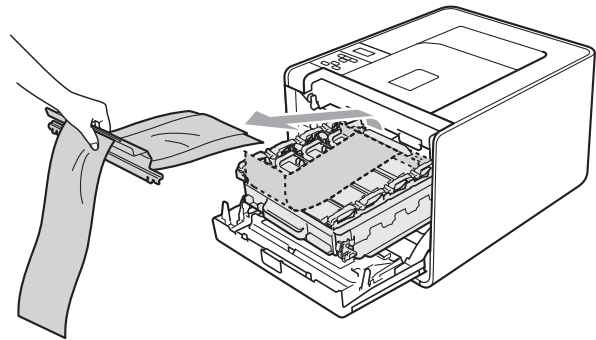

f Remove the 4 orange packing pieces.

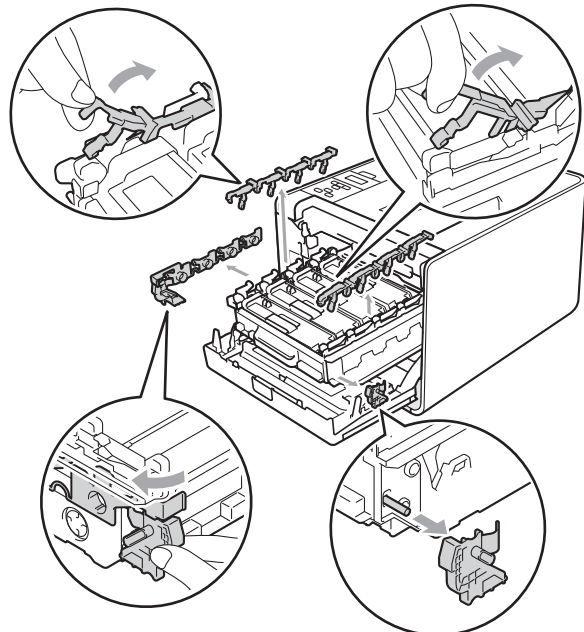

g Push the drum unit firmly back into the machine.

h Close the front cover of the machine.

3

Load paper in the paper tray

- a** Pull the paper tray completely out of the machine.

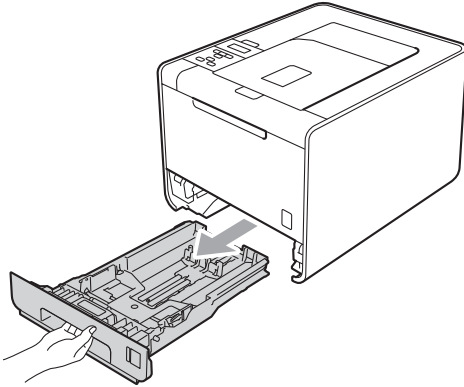

- b** While pressing the green paper-guide release lever ①, slide the paper guides to fit the paper size you are loading in the tray. Make sure that the guides are firmly in the slots.

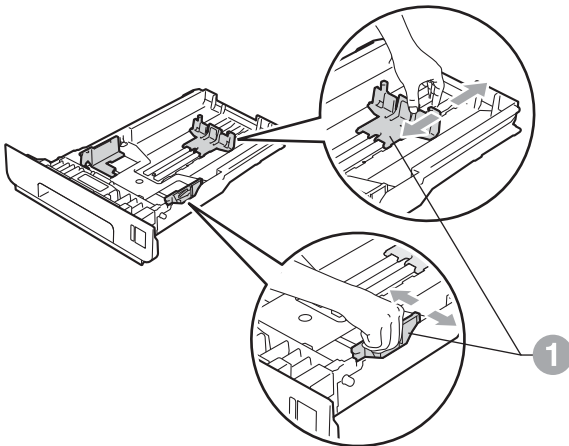

- c** Fan the stack of paper well to avoid paper jams and misfeeds.

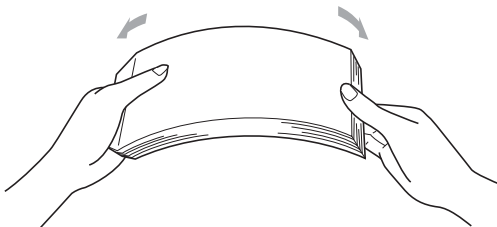

d

Put paper in the tray and make sure:

- The paper is below the maximum paper mark (▼▼▼) ①.
- Over filling the paper tray will cause paper jams.
- The side to be printed on must be face down.
- The paper guides touch the sides of the paper so it will feed properly.

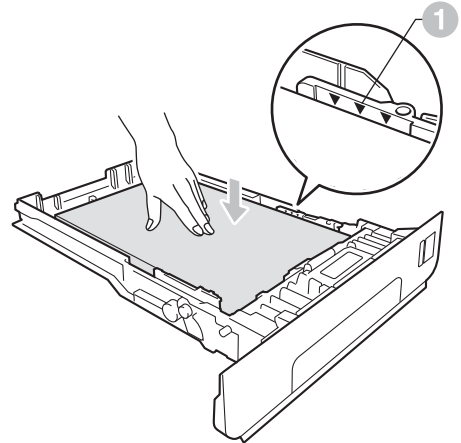

e

Put the paper tray firmly back in the machine. Make sure that it is completely inserted into the machine.

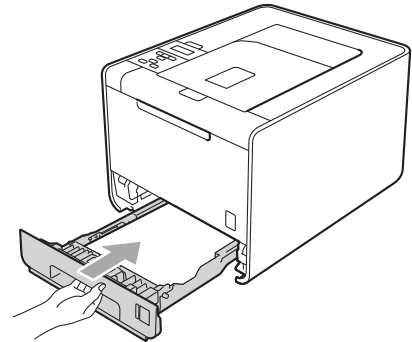

For more information about recommended paper, see *Recommended paper and print media* in the *User's Guide*.

4 Print a test page

! IMPORTANT
DO NOT connect the interface cable yet.

- a** Connect the AC power cord to the machine and then connect it to an AC power outlet.
- b** Remove the label covering the machine's power switch, and then switch the machine on.

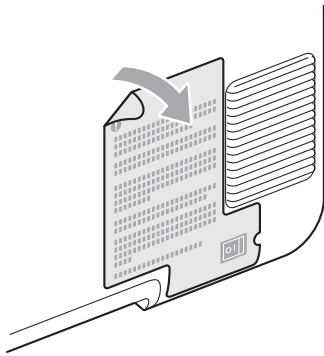

- c** After the machine has finished warming up, the LCD will show *Ready*.

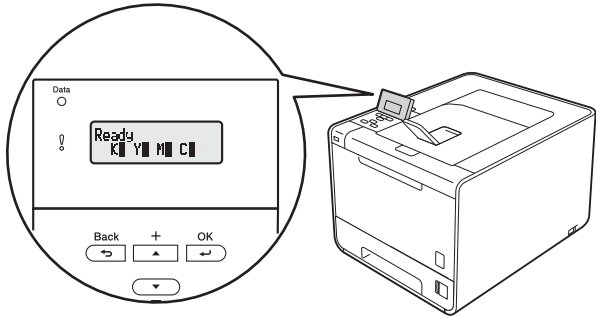

Note
You can adjust the angle of the display by lifting it.

- d** Press **Go**. The machine will print a test page. Check that the test page has printed correctly.

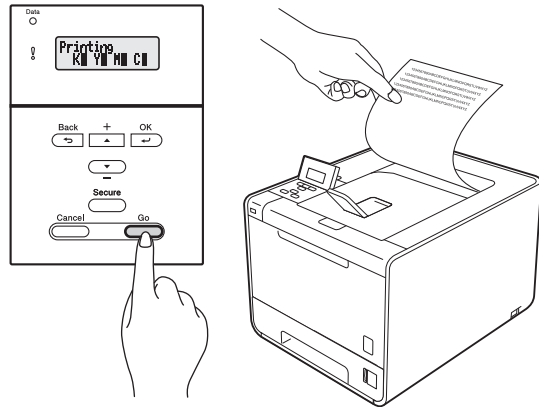

Note
This function will not be available after the first print job you send from your computer.

5

Set your language

- a** Press + or - to choose `General Setup`.
Press **OK**.
- b** Press **OK** to choose `Local Language`.
- c** Press + or - to choose your language.
Press **OK**.

Now go to

Next page to install the printer driver.

6

Choose your connection type

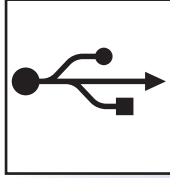
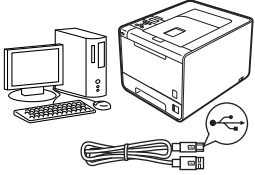

For USB Interface Users

Windows[®], go to page 8
Macintosh, go to page 9

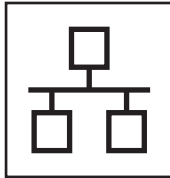
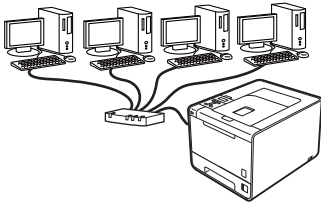

For Wired Network

Windows[®], go to page 10
Macintosh, go to page 14

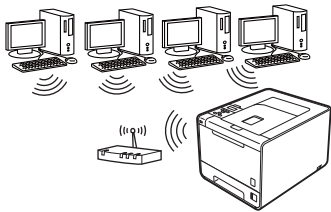

For Wireless Network

Windows[®] and Macintosh,
go to page 16



Note

You can download the latest drivers and utilities for your machine from the Brother Solutions Center at <http://solutions.brother.com/>.

USB	Windows [®]
	Macintosh
Wired Network	Windows [®]
	Macintosh
Wireless Network	Windows [®]
	Macintosh



For USB Interface Cable Users for Windows®

7 Before you install

a Make sure that your computer is ON and you are logged on with Administrator rights.

! IMPORTANT

- If there are any programs running, close them.
- The screens may differ depending on your operating system.

b Turn off the machine and make sure the USB interface cable is **NOT** connected to the machine, and then begin installing the printer driver. If you have already connected the cable, disconnect it.

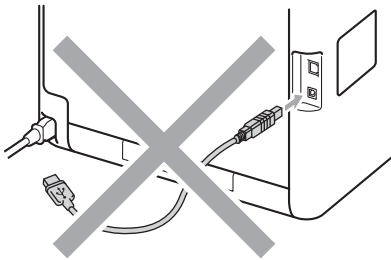

8 Install the printer driver

a Put the installation CD-ROM into your CD-ROM drive. If prompted, select your model and language.

Note

If the Brother screen does not appear automatically, go to **My Computer (Computer)**, double-click the CD-ROM icon, and then double-click **start.exe**.

b Click **Install Printer Driver**, and click **Yes** if you accept the license agreement.



Note

- For Windows Vista® and Windows® 7 users, when the **User Account Control** screen appears, click **Allow** or **Yes**.
- If you want to install the PS driver (BR-Script3 printer driver), choose **Custom Install** and then follow the on-screen instructions.

c Follow the on-screen instructions until this screen appears.

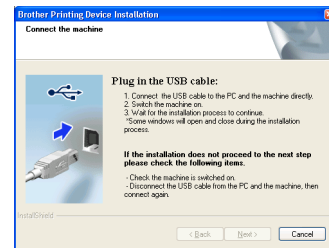

d Connect the USB cable to the USB connector on the machine marked with the  symbol, and then connect the cable to your computer.

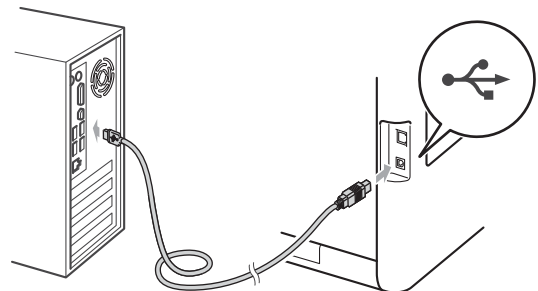

e Turn the machine on, and follow the on-screen instructions to complete setup.

Finish

The installation is now complete.

Note

- Depending on your security settings, a Windows Security or antivirus software window may appear when using the machine or its software. Please allow or permit the window to continue.
- **XML Paper Specification Printer Driver**
The XML Paper Specification Printer Driver is the most suitable driver when printing from the applications that use the XML Paper Specification documents. Please download the latest driver by accessing the Brother Solutions Center at <http://solutions.brother.com/>.



For USB Interface Cable Users for Macintosh

7 Before you install

- a Make sure your machine is connected to the power and your Macintosh is ON. You must be logged on with Administrator rights.

IMPORTANT
 For Mac OS X 10.4.10 users, upgrade to Mac OS X 10.4.11 - 10.6.x. (For the latest drivers and information on the Mac OS X you are using, visit <http://solutions.brother.com/>.)

Note
 If you want to setup the PS driver (BR-Script3 printer driver), please go to the Brother Solutions Center at <http://solutions.brother.com/> and click Downloads on your model page to download the driver and visit FAQ's for installation instructions.

- b Connect the USB cable to the USB connector on the machine marked with the symbol, and then connect the cable to your Macintosh.

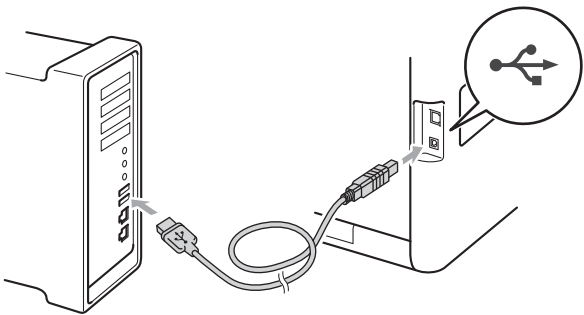

- c Make sure the machine power switch is on.

8 Install the printer driver

- a Put the installation CD-ROM into your CD-ROM drive.
- b Double-click the **Start Here OSX** icon. Follow the on-screen instructions.



Note
 It may take a few minutes for installation to complete.

- c Follow the on-screen instructions until this screen appears. Choose your machine from the list, and then click **OK**.

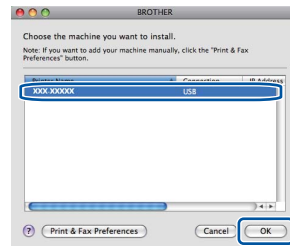

- d When this screen appears, click **Next**.

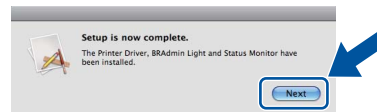

Note
 When the **Brother Support** screen appears, make your selection and follow the on-screen instructions.

Finish The installation is now complete.

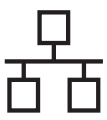

For Wired Network Interface Cable Users for Windows® (For Peer-to-Peer network users)

7 Before you install

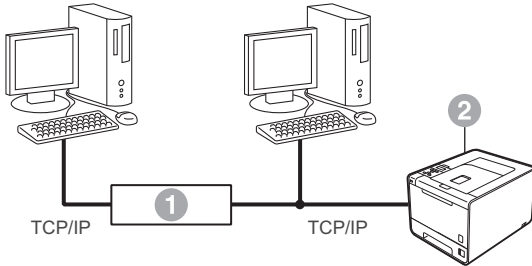

- 1 Router
- 2 Machine

Note

If you are going to connect the machine to your network, we recommend that you contact your system administrator prior to installation.

- a Make sure that your computer is ON and you are logged on with Administrator rights.

! IMPORTANT

- If there are any programs running, close them.
- The screens may differ depending on your operating system.

- b Remove the protective cap from the LAN connector.

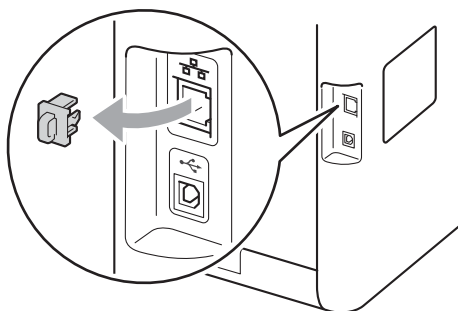

- c Connect the network interface cable to the LAN connector marked with a  symbol and then connect it to a free port on your hub.

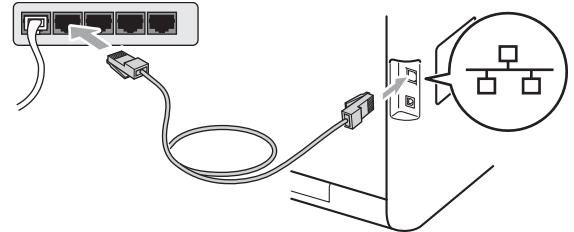

- d Make sure the machine power switch is on.

8 Install the printer driver

- a Put the installation CD-ROM into your CD-ROM drive. If prompted, select your model and language.

Note

If the Brother screen does not appear automatically, go to **My Computer (Computer)**, double-click the CD-ROM icon, and then double-click **start.exe**.

- b Click **Install Printer Driver**, and click **Yes** if you accept the license agreement.



Note

- For Windows Vista® and Windows® 7 users, when the **User Account Control** screen appears, click **Allow** or **Yes**.
- If you want to install the PS driver (BR-Script3 printer driver), choose **Custom Install** and then follow the on-screen instructions.

- c Follow the on-screen instructions to complete setup.

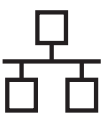

Note

You can find your machine's IP Address and the node name by printing out the Printer Settings Page. See *Print the Printer Settings Page* on page 25.

Finish

The installation is now complete.



Note

- If you use a specified IP Address for the machine, you must set the Boot Method to Static by using the control panel. For more information, see *Network menu* in the *Network User's Guide*.
- Depending on your security settings, a Windows Security or antivirus software window may appear when using the machine or its software. Please allow or permit the window to continue.
- **XML Paper Specification Printer Driver**
The XML Paper Specification Printer Driver is the most suitable driver when printing from the applications that use the XML Paper Specification documents. Please download the latest driver by accessing the Brother Solutions Center at <http://solutions.brother.com/>.

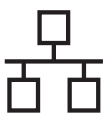

For Wired Network Interface Cable Users for Windows® (For shared network users)

7 Before you install

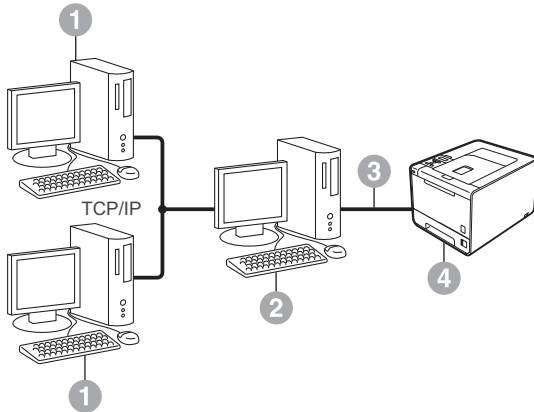

- 1 Client computer
- 2 Also known as "Server" or "Print server"
- 3 TCP/IP or USB
- 4 Machine

Note

If you are going to connect the machine to your network, we recommend that you contact your system administrator prior to installation.

- a Make sure that your computer is ON and you are logged on with Administrator rights.

IMPORTANT

- If there are any programs running, close them.
- The screens may differ depending on your operating system.

- b Make sure the machine power switch is on.

8 Install the printer driver

- a Put the installation CD-ROM into your CD-ROM drive. If prompted, select your model and language.

Note

If the Brother screen does not appear automatically, go to **My Computer (Computer)**, double-click the CD-ROM icon, and then double-click **start.exe**.

- b Click **Install Printer Driver**, and click **Yes** if you accept the license agreement.



Note

- For Windows Vista® and Windows® 7 users, when the **User Account Control** screen appears, click **Allow** or **Yes**.
- If you want to install the PS driver (BR-Script3 printer driver), choose **Custom Install** and then follow the on-screen instructions.

- c Follow the on-screen instructions until this screen appears. Choose your machine's queue, and then click **OK**.

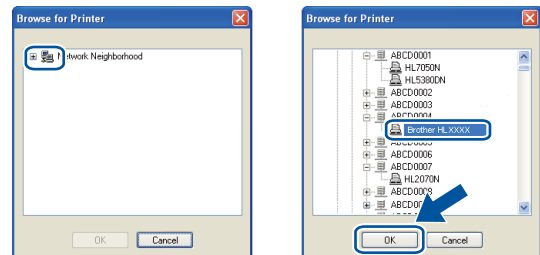

Note

Contact your administrator if you do not know the location or the name of the machine queue on the network.

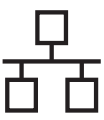

- d** Follow the on-screen instructions to complete setup.

Finish

The installation is now complete.



Note

- Depending on your security settings, a Windows Security or antivirus software window may appear when using the machine or its software. Please allow or permit the window to continue.
- **XML Paper Specification Printer Driver**
The XML Paper Specification Printer Driver is the most suitable driver when printing from the applications that use the XML Paper Specification documents. Please download the latest driver by accessing the Brother Solutions Center at <http://solutions.brother.com/>.

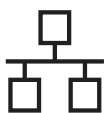

For Wired Network Interface Cable Users for Macintosh

7 Before you install

- a** Make sure your machine is connected to the power and your Macintosh is ON. You must be logged on with Administrator rights.

! IMPORTANT

For Mac OS X 10.4.10 users, upgrade to Mac OS X 10.4.11 - 10.6.x. (For the latest drivers and information on the Mac OS X you are using, visit <http://solutions.brother.com/>.)

Note

If you want to setup the PS driver (BR-Script3 printer driver), please go to the Brother Solutions Center at <http://solutions.brother.com/> and click Downloads on your model page to download the driver and visit FAQ's for installation instructions.

- b** Remove the protective cap from the LAN connector.

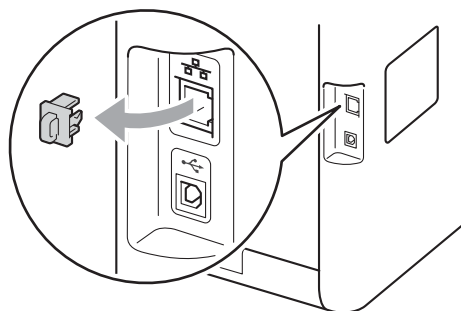

- c** Connect the network interface cable to the LAN connector marked with a  symbol and then connect it to a free port on your hub.

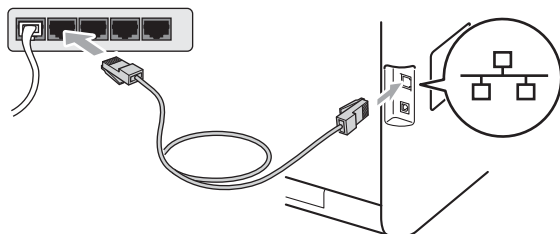

- d** Make sure the machine power switch is on.

8 Install the printer driver

- a** Put the installation CD-ROM into your CD-ROM drive.
- b** Double-click the **Start Here OSX** icon. Follow the on-screen instructions.



Note

It may take a few minutes for installation to complete.

- c** Follow the on-screen instructions until this screen appears. Choose your machine from the list, and then click **OK**.

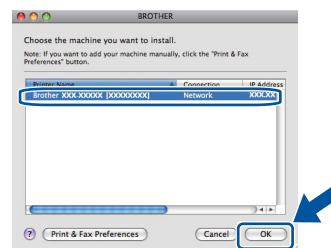

Note

- If there is more than one of the same model connected on your network, the MAC Address (Ethernet Address) will be displayed after the model name.
- You can find your machine's MAC Address (Ethernet Address) and IP Address by printing out the Printer Settings Page. See *Print the Printer Settings Page* on page 25.

- d** When this screen appears, click **Next**.

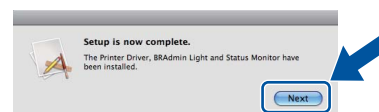

Note

When the **Brother Support** screen appears, make your selection and follow the on-screen instructions.

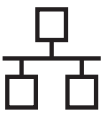

Finish

The installation is now complete.



Note

If you use a specified IP Address for the machine, you must set the Boot Method to Static by using the control panel. For more information, see *Network menu* in the *Network User's Guide*.



For Wireless Network Interface Users

7

Before you begin

First you must configure the wireless network settings of your machine to communicate with your network access point/router. After the machine is configured to communicate with your access point/router, computers on your network will have access to the machine. To use the machine from these computers, you will need to install the printer driver. The following steps will guide you through the configuration and installation process.

! IMPORTANT

- If you are going to connect the machine to your network, we recommend that you contact your system administrator prior to installation. You must know your wireless network settings before you proceed with this installation.
- If you have previously configured the wireless settings of the machine, you must reset the print server back to its factory default settings.
 1. On your machine, press + or - to choose `Network`, and press `OK`.
 2. Press + or - to choose `Network Reset`, and press `OK`.
 3. Press + to choose `Reset`. When `Reboot OK?` appears, press + to choose `Yes`.



Note

- To achieve optimum results with normal everyday document printing, place the Brother machine as close to the network access point/router as possible with minimal obstructions. Large objects and walls between the two devices as well as interference from other electronic devices can affect the data transfer speed of your documents.

Due to these factors, wireless may not be the best method of connection for all types of documents and applications. If you are printing large files, such as multi-page documents with mixed text and large graphics, you may want to consider choosing wired Ethernet for a faster data transfer or USB for the fastest throughput speed.
- Although the Brother HL-4570CDW(T) can be used in both a wired and wireless network, only one of the connection methods can be used at a time.

Infrastructure Mode

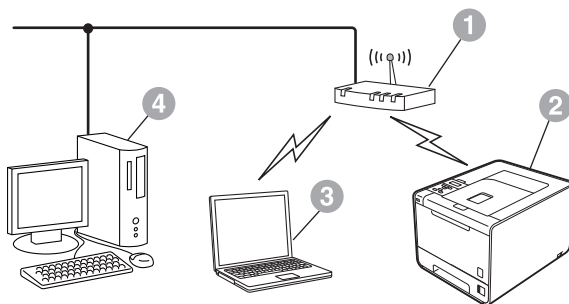

- 1 Access point/router
- 2 Wireless Network machine (your machine)
- 3 Wireless capable computer connected to the access point/router
- 4 Wired computer connected to the access point/router



8 Confirm your network environment (Infrastructure Mode)

The following instructions will offer two methods for installing your Brother machine in a wireless network environment.

Note
To setup your machine in any other wireless environment, you can find instructions in the *Network User's Guide*.

a If your WLAN access point/router supports automatic wireless mode (Wi-Fi Protected Setup or AOSS™)

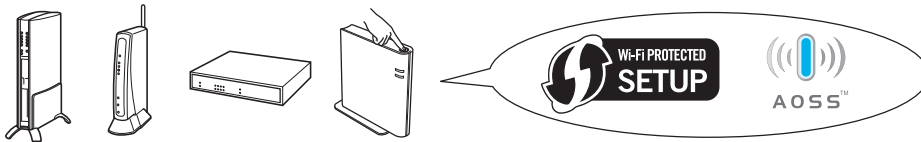

Now go to

page 18

b If your WLAN access point/router does not support Wi-Fi Protected Setup or AOSS™, write down the wireless network settings of your WLAN access point/router.

IMPORTANT

Please do not contact Brother Customer Service for assistance without the wireless security information. We cannot assist you in locating your network security settings.

Network name (SSID/ESSID)	Network Key

For example:

Network name (SSID/ESSID)	Network Key
HELLO	12345678

Note

- If you do not know this information (Network Name (SSID/ESSID) and Network Key), you cannot continue the wireless setup.
- How can I find this information (Network Name (SSID/ESSID) and Network Key)
 1. You should see the documentation provided with your WLAN access point/router.
 2. The initial network name could be the manufacturer's name or the model name.
 3. If you do not know the security information, please consult the router manufacturer, your system administrator or internet provider.

Now go to

page 19



Connecting the Brother machine to the wireless network

9

Configure the wireless settings using the automatic wireless mode

- a** Confirm your WLAN access point/router has the Wi-Fi Protected Setup or AOSS™ symbol as shown below.



- b** Place the Brother machine within range of your Wi-Fi Protected Setup or AOSS™ access point/router. The range may differ depending on your environment. Refer to the instructions provided with your access point/router.

- c** On your machine, press **+** or **-** to choose `Network` and press **OK**.
Press **+** or **-** to choose `WLAN` and press **OK**.
Press **+** or **-** to choose `WPS/AOSS` and press **OK**.

When `WLAN Enable?` is displayed, press **+** to accept. This will start the wireless setup wizard.

Otherwise press **Cancel** to exit from the wireless setup wizard.

When `Press Key on rtr` appears, press the Wi-Fi Protected Setup or AOSS™ button on your WLAN access point/router. See the user's guide for your WLAN access point/router for instructions. And then press **+**.

This feature will automatically detect which mode (Wi-Fi Protected Setup or AOSS™) your access point/router uses to configure your machine.



Note

If your WLAN access point/router supports Wi-Fi Protected Setup (PIN Method) and you want to configure your machine using the PIN (Personal Identification Number) Method, see *Using the PIN Method of Wi-Fi Protected Setup* in the *Network User's Guide*.

- d** A connection result message appears on the LCD and a WLAN report will automatically be printed.

If the connection failed, check the error code on the printed report and refer to *Troubleshooting* on page 20.



Wireless setup is now complete. A four level indicator at the right of your machine's LCD will show the wireless signal strength of your access point/router.

To install the printer driver, continue to step 10.

For Windows® Users:

Now go to
page 23

For Macintosh Users:

Now go to
page 24



9 Configure the wireless settings (typical Wireless Setup in infrastructure mode)

! IMPORTANT

You must have the wireless settings you wrote down for your network in step 8 on page 17 before you proceed.

- a** On your machine, press **+** or **-** to choose *Network* and press **OK**. Press **+** or **-** to choose *WLAN* and press **OK**. Press **+** or **-** to choose *Setup Wizard* and press **OK**.

When *WLAN Enable?* is displayed, press **+** to accept. This will start the wireless setup wizard.

Otherwise press **Cancel** to exit from the wireless setup wizard.

- b** The machine will search for available SSIDs. If a list of SSIDs is displayed, use the **+** or **-** key to choose the SSID you wrote down in step 8 on page 17, then press **OK**.

If you are using an authentication and encryption method that requires a Network Key, go to **c**.

If your authentication method is Open System and your encryption mode is None, go to **e**.

If your WLAN access point/router supports Wi-Fi Protected Setup, *WPS is available* appears. Press **+**. To connect your machine using the automatic wireless mode, press **+** to choose *Yes*. (If you choose *No*, go to **c** to enter the Network Key.) When *Press WPS on rtr* appears, press the Wi-Fi Protected Setup button on your WLAN access point/router, and then press **+** twice. Go to **e**.



Note

- It will take several seconds to display a list of available SSIDs.
- If a list of SSIDs is not displayed, make sure your access point is on. Move your machine closer to the access point and try starting from **a** again.

If you use your machine in an IEEE 802.1x supported wireless network, see *Using IEEE 802.1x authentication* in the *Network User's Guide*.

If your access point is set to not broadcast the SSID you will have to manually add the SSID name. For details, see *Configuring your machine when the SSID is not broadcast* in the *Network User's Guide*.

- c** Enter the Network Key you wrote down in step 8 on page 17.

To enter a letter or number, hold down or repeatedly press the **+** or **-** key until the letter you want appears, and then press **OK**.

To delete the letters you have entered, press the **Back** key.

For more information, see *Entering Text for Wireless Settings* on page 22.

Press **OK** when you have entered all the characters, then press **OK** for *Yes* to apply your settings. Go to **d**.

- d** Your machine will now try to connect to your wireless network using the information you have entered.

- e** A connection result message appears on the LCD and a WLAN report will automatically be printed.

If the connection failed, check the error code on the printed report and refer to *Troubleshooting* on page 20.



Wireless setup is now complete. A four level indicator at the right of your machine's LCD will show the wireless signal strength of your access point/router.

To install the printer driver, continue to step 10.

For Windows® Users:

Now go to page 23

For Macintosh Users:

Now go to page 24



Troubleshooting

! IMPORTANT

Please do not contact Brother Customer Service for assistance without the wireless security information. We cannot assist you in locating your network security settings.

How can I find the wireless settings (Network Name (SSID/ESSID) and Network Key)

1. You should see the documentation provided with your WLAN access point/router.
2. The initial network name could be the manufacturer's name or the model name.
3. If you do not know the security information, please consult the router manufacturer, your system administrator or internet provider.

- * The Network Key may also be described as the Password, Security Key or Encryption Key.
- * If the WLAN access point/router is set to not broadcast the SSID, the SSID will not automatically be detected. You will have to manually enter the SSID name. See *Configuring your machine when the SSID is not broadcast* in the *Network User's Guide*.

WLAN report

If the WLAN report that printed shows that the connection failed, check the error code on the printed report and refer to the following instructions.

Error code	Recommended Solutions
TS-01	<p>The wireless setting is not activated, turn the wireless setting to ON.</p> <ul style="list-style-type: none"> - If a LAN cable is connected to your machine, disconnect it and turn the wireless setting of your machine to ON. <ol style="list-style-type: none"> 1. On your machine, press + or - to choose <code>Network</code> and press OK. 2. Press + or - to choose <code>WLAN</code> and press OK. 3. Press + or - to choose <code>Setup Wizard</code> and press OK. 4. When <code>WLAN Enable?</code> is displayed, press + to accept. This will start the wireless setup wizard.
TS-02	<p>The WLAN access point/router cannot be detected.</p> <ol style="list-style-type: none"> 1. Check the following 4 points. <ul style="list-style-type: none"> - Make sure that the WLAN access point/router is powered on. - Move your machine to an obstruction-free area, or closer to the wireless access point/router. - Temporarily place your machine within about one meter (3.3 feet) from the WLAN access point when you are configuring the wireless settings. - If your WLAN access point/router is using MAC address filtering, confirm the MAC address of the Brother machine is allowed in the filter. 2. If you manually entered the SSID and security information (SSID/authentication method/encryption method/Network Key) the information may be incorrect. Reconfirm the SSID and security information and reenter the correct information as necessary. See <i>How can I find the wireless settings (Network Name (SSID/ESSID) and Network Key)</i> on page 20 to confirm.



For Wireless Network Users

Error code	Recommended Solutions												
TS-03	<p>The wireless network and security setting you entered may be incorrect. Reconfirm the wireless network settings.</p> <p>* Check if the entered or selected SSID/authentication method/encryption method/UserID/Userpass are correct.</p> <p>See <i>How can I find the wireless settings (Network Name (SSID/ESSID) and Network Key)</i> on page 20 to confirm.</p>												
TS-04	<p>The Authentication/Encryption methods used by the selected WLAN access point/router are not supported by your machine.</p> <p>For infrastructure mode, change the authentication and encryption methods of the WLAN access point/router. Your machine supports the following authentication methods WPA, WPA2, OPEN and Shared key. WPA supports TKIP or AES encryption methods. WPA2 supports AES for the encryption method. OPEN and Shared key correspond to WEP encryption.</p> <p>If your problem is not solved the SSID or network settings you entered may be incorrect. Reconfirm the wireless network settings.</p> <p>Combined table of authentication and encryption methods</p> <table border="1" data-bbox="331 943 1090 1240"> <thead> <tr> <th data-bbox="331 943 710 981">Authentication method</th> <th data-bbox="715 943 1090 981">Encryption method</th> </tr> </thead> <tbody> <tr> <td data-bbox="331 987 710 1070" rowspan="2">WPA-Personal</td> <td data-bbox="715 987 1090 1025">TKIP</td> </tr> <tr> <td data-bbox="715 1032 1090 1070">AES</td> </tr> <tr> <td data-bbox="331 1077 710 1115">WPA2-Personal</td> <td data-bbox="715 1077 1090 1115">AES</td> </tr> <tr> <td data-bbox="331 1122 710 1205" rowspan="2">OPEN</td> <td data-bbox="715 1122 1090 1160">WEP</td> </tr> <tr> <td data-bbox="715 1167 1090 1205">NONE (without encryption)</td> </tr> <tr> <td data-bbox="331 1211 710 1240">Shared key</td> <td data-bbox="715 1211 1090 1240">WEP</td> </tr> </tbody> </table> <p>See <i>How can I find the wireless settings (Network Name (SSID/ESSID) and Network Key)</i> on page 20 to confirm.</p> <p>For ad-hoc mode, change the authentication and encryption methods of your computer for the wireless setting. Your machine supports OPEN authentication method only, with optional WEP encryption.</p>	Authentication method	Encryption method	WPA-Personal	TKIP	AES	WPA2-Personal	AES	OPEN	WEP	NONE (without encryption)	Shared key	WEP
Authentication method	Encryption method												
WPA-Personal	TKIP												
	AES												
WPA2-Personal	AES												
OPEN	WEP												
	NONE (without encryption)												
Shared key	WEP												
TS-05	<p>The security information (SSID/Network Key) is incorrect. Reconfirm the SSID and security information (Network Key). If your router uses WEP encryption, enter the key used as the first WEP key. Your Brother machine supports the use of the first WEP key only.</p> <p>See <i>How can I find the wireless settings (Network Name (SSID/ESSID) and Network Key)</i> on page 20 to confirm.</p>												
TS-06	<p>The wireless security information (Authentication method/Encryption method/Network Key) is incorrect. Reconfirm the wireless security information (Authentication method/Encryption method/Network Key) in the table of TS-04. If your router uses WEP encryption, enter the key used as the first WEP key. Your Brother machine supports the use of the first WEP key only.</p> <p>See <i>How can I find the wireless settings (Network Name (SSID/ESSID) and Network Key)</i> on page 20 to confirm.</p>												



Error code	Recommended Solutions
TS-07	<p>The machine cannot detect a WLAN access point/router that has WPS or AOSS™ enabled.</p> <p>If you would like to configure your wireless settings using WPS or AOSS™, you must operate both your machine and the WLAN access point/router. Confirm your WLAN access point/router supports WPS or AOSS™ and try starting again.</p> <div data-bbox="858 416 1046 725" data-label="Image"> </div> <p>If you do not know how to operate your WLAN access point/router using WPS or AOSS™, see the documentation provided with your WLAN access point/router, ask the manufacturer of your WLAN access point/router or ask your network administrator.</p>
TS-08	<p>Two or more WLAN access points that have WPS or AOSS™ enabled are detected.</p> <ul style="list-style-type: none"> - Confirm that only one WLAN access point/router within range has the WPS or AOSS™ method active and try again. - Try starting again after a few minutes in order to avoid interference from other access points.

Entering Text for Wireless Settings

Hold down or repeatedly press the + or - key to select a character from the list below:

(space) !"#\$%&'()*+,-./0123456789:;<=>?@
 ABCDEFGHIJKLMNOPQRSTUVWXYZ[?]^_`abcdefghijklmnopqrstuvwxyz{|}~

Press the **Back** key to delete the letters you have entered.



Install the Printer Driver for Windows®

10 Before you install

- a Make sure that your computer is ON and you are logged on with Administrator rights.

! IMPORTANT

- If there are any programs running, close them.
- The screens may differ depending on your operating system.

- b Make sure the machine power switch is on.

11 Install the printer driver

- a Put the installation CD-ROM into your CD-ROM drive. If prompted, select your model and language.

Note

If the Brother screen does not appear automatically, go to **My Computer (Computer)**, double-click the CD-ROM icon, and then double-click **start.exe**.

- b Click **Install Printer Driver**, and click **Yes** if you accept the license agreement.



Note

For Windows Vista® and Windows® 7 users, when the **User Account Control** screen appears, click **Allow** or **Yes**.

- c Choose **Wireless Network Connection**.

Note

If you want to install the PS driver (BR-Script3 printer driver), choose **Custom Install** and then follow the on-screen instructions.

- d Choose your machine from the list, and then click **Next**.

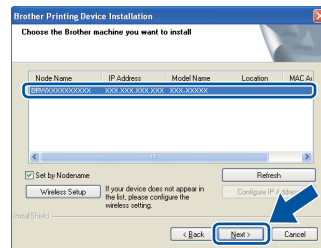

! IMPORTANT

DO NOT cancel any of the screens during the installation.

- e Follow the on-screen instructions to complete setup.

Finish The installation is now complete.

Note

- If you use a specified IP Address for the machine, you must set the Boot Method to Static by using the control panel. For more information, see *Network menu* in the *Network User's Guide*.
- Depending on your security settings, a Windows Security or antivirus software window may appear when using the machine or its software. Please allow or permit the window to continue.
- **XML Paper Specification Printer Driver**
The XML Paper Specification Printer Driver is the most suitable driver when printing from the applications that use the XML Paper Specification documents. Please download the latest driver by accessing the Brother Solutions Center at <http://solutions.brother.com/>.



Install the Printer Driver for Macintosh

10 Before you install

- a** Make sure your machine is connected to the power and your Macintosh is ON. You must be logged on with Administrator rights.

! IMPORTANT

For Mac OS X 10.4.10 users, upgrade to Mac OS X 10.4.11 - 10.6.x. (For the latest drivers and information on the Mac OS X you are using, visit <http://solutions.brother.com/>.)

Note

If you want to setup the PS driver (BR-Script3 printer driver), please go to the Brother Solutions Center at <http://solutions.brother.com/> and click Downloads on your model page to download the driver and visit FAQ's for installation instructions.

11 Install the printer driver

- a** Put the installation CD-ROM into your CD-ROM drive.
- b** Double-click the **Start Here OSX** icon. Follow the on-screen instructions.



- c** Choose **Wireless Network Connection**.



! IMPORTANT

DO NOT cancel any of the screens during the installation.

Note

It may take a few minutes for installation to complete.

- d** Choose your machine from the list, and then click **OK**.

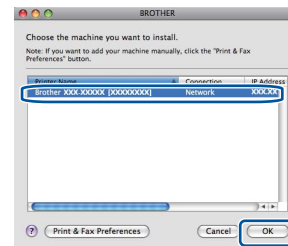

Note

- If there is more than one of the same model connected on your network, the MAC Address (Ethernet Address) will be displayed after the model name.
- You can find your machine's MAC Address (Ethernet Address) and IP Address by printing out the Printer Settings Page. See *Print the Printer Settings Page* on page 25.

- e** When this screen appears, click **Next**.

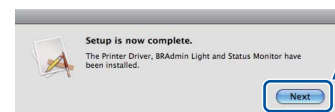

Note

When the **Brother Support** screen appears, make your selection and follow the on-screen instructions.

Finish

The installation is now complete.

Note

If you use a specified IP Address for the machine, you must set the Boot Method to Static by using the control panel. For more information, see *Network menu* in the *Network User's Guide*.

Web Based Management (web browser)

The Brother print server is equipped with a web server that allows you to monitor its status or change some of its configuration settings, using HTTP (Hyper Text Transfer Protocol).

Note

- The login name for the Administrator is '**admin**' (case sensitive) and the default password is '**access**'.
- We recommend Microsoft® Internet Explorer® 6.0 (or greater) or Firefox 3.0 (or greater) for Windows® and Safari 3.0 (or greater) for Macintosh. Please also make sure that JavaScript and Cookies are always enabled in whichever browser you use. To use a web browser, you will need to know the IP Address of the print server. The IP Address of the print server is listed on the Print Setting Page.

- a Open your browser.
- b Type `http://machine_ip_address/` into your browser (where `machine_ip_address` is the IP address or the print server name).
 - For example: `http://192.168.1.2/`

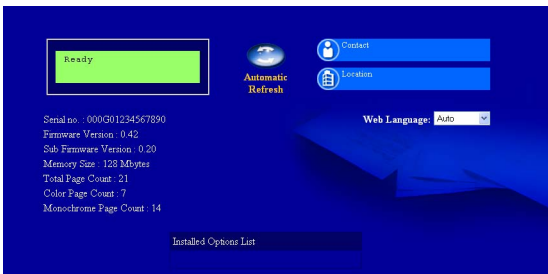

See *Web Based Management* in the *Network User's Guide*.

Reset the network settings to the factory default

To reset all network settings of the print server to its factory default, follow the steps below.

- a Press **+** or **-** to choose `Network`. Press **OK**.
- b Press **+** or **-** to choose `Network Reset`. Press **OK**.
- c Press **+** to choose `Reset`.
- d Press **+** to choose `Yes` for reboot. The machine will re-start.

Print the Printer Settings Page

The Printer Settings Page lists all the current printer settings, including network settings.

- a Press **+** or **-** to choose `Machine Info..` Press **OK**.
- b Press **OK** to choose `Print Settings`.

Note

If the **IP address** on the Printer Settings Page shows **0.0.0.0**, wait for one minute and try again.

Color Correction (if needed)

Color Calibration

The output density for each color may vary depending on the environment the machine is in, such as temperature and humidity. Calibration helps you to improve the color density.

Note

- If you print using the Direct Print feature or the BR-Script printer driver, you need to perform the calibration from the control panel. See *Using the control panel* on page 26.
- If you print using the Windows® printer driver, the driver will get the calibration data automatically if both **Use Calibration Data** and **Get Device Data Automatically** are on. See *Advanced tab* in the *User's Guide*.
- If you print using the Macintosh printer driver, you need to perform the calibration using **Status Monitor**. After turning **Status Monitor** on, choose **Color Calibration** from **Control** menu. See *Color Calibration* in the *User's Guide*.

Using the control panel

- Press **+** or **-** to choose **Color Correction**. Press **OK**.
- Press **+** or **-** to choose **ColorCalibration**. Press **OK**.
- Press **OK** to choose **Calibrate**.
- Press **+** to choose **Yes**.

You can reset the calibration parameters back to those set at the factory.

- Press **+** or **-** to choose **Color Correction**. Press **OK**.
- Press **+** or **-** to choose **ColorCalibration**. Press **OK**.
- Press **+** or **-** to choose **Reset**. Press **OK**.
- Press **+** to choose **Reset**.

Color Registration

Auto Registration

You can adjust the print position of each color automatically.

- Press **+** or **-** to choose **Color Correction**. Press **OK**.
 - Press **+** or **-** to choose **Auto Regist..**. Press **OK**.
 - Press **OK** to choose **Registration**.
 - Press **+** to choose **Yes**.
-  To adjust the print position of each color manually, see *Manual Registration* in the *User's Guide*.

Brother CreativeCenter Icon



Get inspired. Double-click the Brother CreativeCenter icon on your desktop to access a FREE web site with many ideas and resources for personal and professional use.



<http://www.brother.com/creativecenter/>

Options and Consumables

Options

The machine has the following optional accessories. You can expand the capabilities of the machine by adding these items. For more information about the optional Lower Tray Unit and compatible SO-DIMM Memory, visit us at <http://solutions.brother.com/>.

 For installing the SO-DIMM Memory, see *Installing extra memory* in the *User's Guide*.

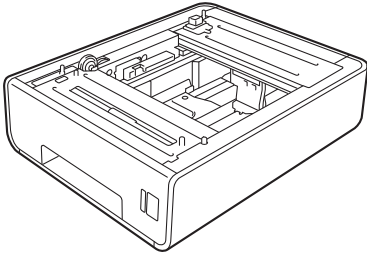
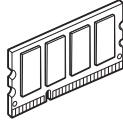
Lower Tray Unit for HL-4570CDW (LT-300CL)	SO-DIMM Memory
<p>Second lower paper tray unit can hold up to 500 sheets of paper. When the tray is installed, the machine expands total input capacity up to 800 sheets.</p> 	<p>You can increase the memory by installing one SO-DIMM (Small Outline Dual In-line Memory Module).</p> 

Consumables

When the time comes to replace consumable items, an error will be indicated by the LCD on the control panel. For more information about the consumables for your machine, visit us at <http://solutions.brother.com/> or contact your local Brother reseller.

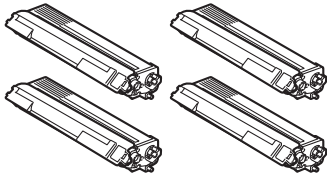
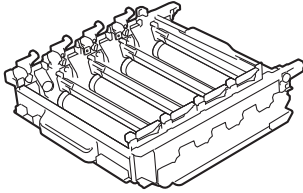
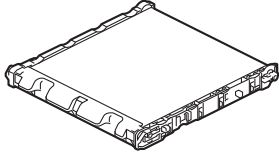
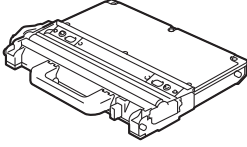
<p>Toner cartridges</p> 	<p>Drum unit</p> 
<p>Belt Unit (BU-300CL)</p> 	<p>Waste Toner Box (WT-300CL)</p> 

 For replacing the consumable items, see *Replacing consumable items* in the *User's Guide*.

Trademarks

The Brother logo is a registered trademark of Brother Industries, Ltd.

Brother is a registered trademark of Brother Industries, Ltd.

Microsoft, Windows, Windows Server and Internet Explorer are registered trademarks of Microsoft Corporation in the United States and/or other countries.

Windows Vista is either a registered trademark or a trademark of Microsoft Corporation in the United States and other countries.

Apple, Macintosh, Safari and TrueType are trademarks of Apple Inc., registered in the United States and other countries.

Wi-Fi and Wi-Fi Alliance are registered trademarks of the Wi-Fi Alliance.

AOSS is a trademark of Buffalo Inc.

Any trade names and product names of companies appearing on Brother products, related documents and any other materials are all trademarks or registered trademarks of those respective companies.

Compilation and Publication

Under the supervision of Brother Industries, Ltd., this manual has been compiled and published, covering the latest product descriptions and specifications.

The contents of this manual and the specifications of this product are subject to change without notice.

Brother reserves the right to make changes without notice in the specifications and materials contained herein and shall not be responsible for any damages (including consequential) caused by reliance on the materials presented, including but not limited to typographical and other errors relating to the publication.

Copyright and License

©2010 Brother Industries, Ltd.

This product includes software developed by the following vendors:

©1983-1998 PACIFIC SOFTWARES, INC.

©2010 Devicescape Software, Inc.

This product includes the "KASAGO TCP/IP" software developed by ZUKEN ELMIC, Inc.